

# DL Hard Cover Booklet

## DL Hard Cover Booklet (99x210mm)

### Artwork Specifications

- \* All files to be supplied as PDF file
- \* All files to be set up as four-colour CMYK not RGB colour mode
- \* All fonts must be outlined/converted to paths
- \* All images and elements to be embed without trim, crop and registration marks
- \* All images within the files must be at least 150dpi or better print resolution
- \* Please specify correct proportions if artwork size is not a 100% full size
- \* All bleeding requirements according to templates

### Sending Your Artwork

- \* Email to [artwork@acesign.com.au](mailto:artwork@acesign.com.au) for size less than **20MB**
- \* Please using (Wetransfer, Google Drive or other free services) to upload your files for larger sizes and sent us the download link.
- \* **Please specify your invoice number when sending your files**

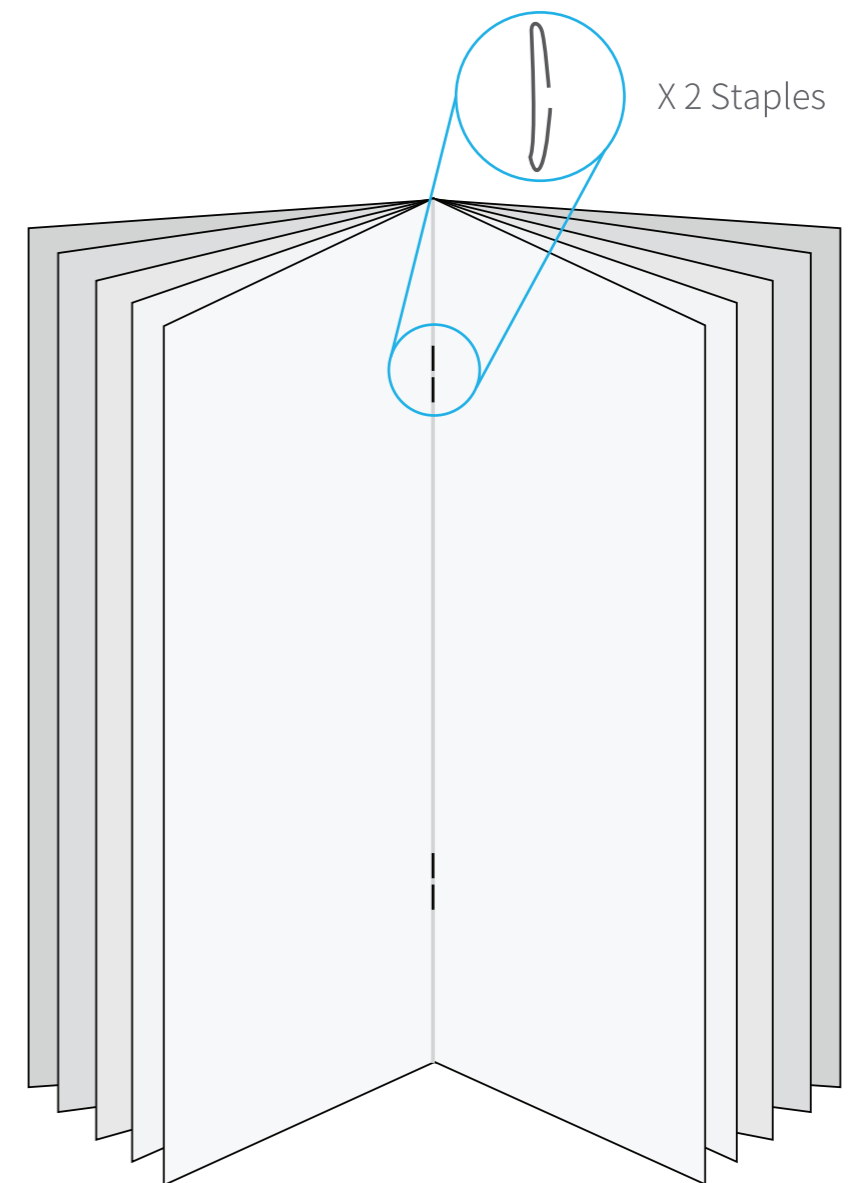

# DL Hard Cover Booklet

## DL Hard Cover Booklet (99x210mm)



### Artwork Specifications

- \* All files to be supplied as PDF file
- \* All files to be set up as four-colour CMYK not RGB colour mode
- \* All fonts must be outlined/converted to paths
- \* All images and elements to be embed without trim, crop and registration marks
- \* All images within the files must be at least 150dpi or better print resolution
- \* Please specify correct proportions if artwork size is not a 100% full size
- \* All bleeding requirements according to templates

### Sending Your Artwork

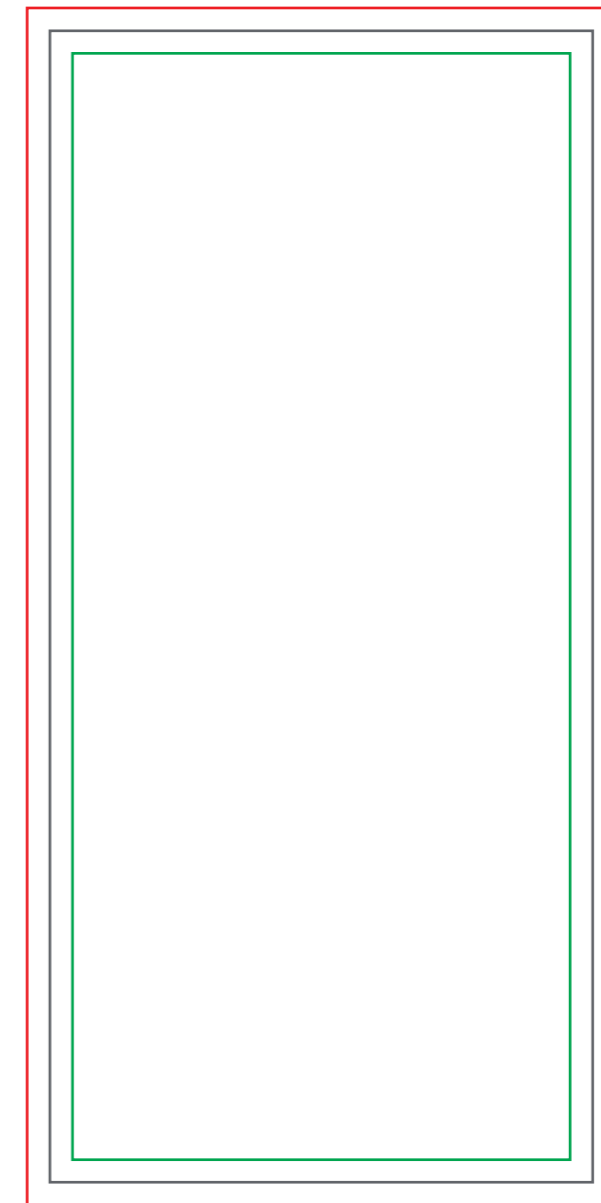
- \* Email to [artwork@acesign.com.au](mailto:artwork@acesign.com.au) for size less than **20MB**
- \* Please using (Wetransfer, Google Drive or other free services) to upload your files for larger sizes and sent us the download link.
- \* **Please specify your invoice number when sending your files**



 Trim size	99mm W x 210mm H
 Bleed	109mm W x 220mm H
 Safe Print Area	89mm W x 200mm H

# A5 Hard Cover Booklet

## A5 Hard Cover Booklet (148.5x210mm)

### Artwork Specifications

- \* All files to be supplied as PDF file
- \* All files to be set up as four-colour CMYK not RGB colour mode
- \* All fonts must be outlined/converted to paths
- \* All images and elements to be embed without trim, crop and registration marks
- \* All images within the files must be at least 150dpi or better print resolution
- \* Please specify correct proportions if artwork size is not a 100% full size
- \* All bleeding requirements according to templates

### Sending Your Artwork

- \* Email to [artwork@acesign.com.au](mailto:artwork@acesign.com.au) for size less than **20MB**
- \* Please using (Wetransfer, Google Drive or other free services) to upload your files for larger sizes and sent us the download link.
- \* **Please specify your invoice number when sending your files**

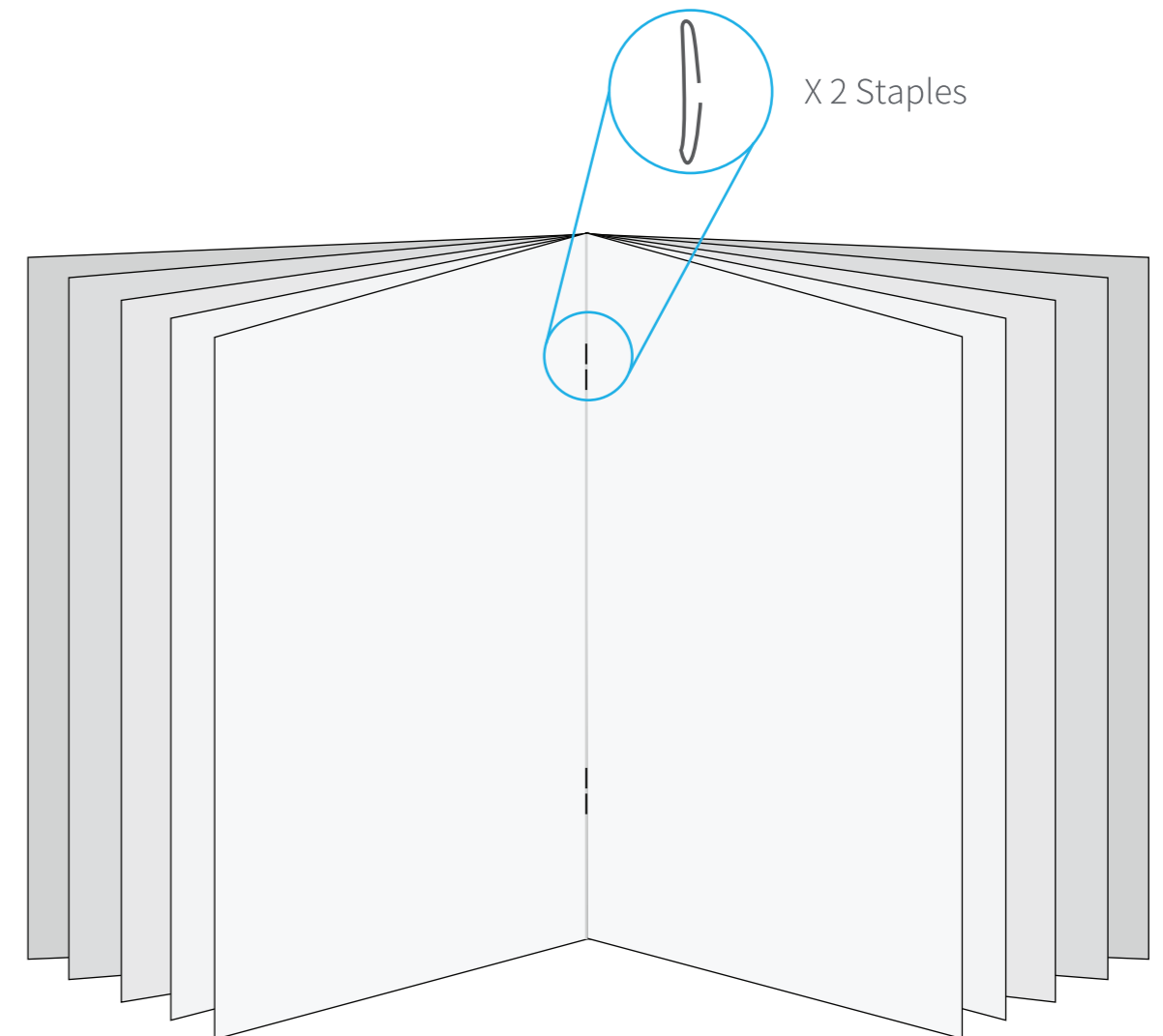

# A5 Hard Cover Booklet

## A5 Hard Cover Booklet (148.5x210mm)



### Artwork Specifications

- \* All files to be supplied as PDF file
- \* All files to be set up as four-colour CMYK not RGB colour mode
- \* All fonts must be outlined/converted to paths
- \* All images and elements to be embed without trim, crop and registration marks
- \* All images within the files must be at least 150dpi or better print resolution
- \* Please specify correct proportions if artwork size is not a 100% full size
- \* All bleeding requirements according to templates

### Sending Your Artwork

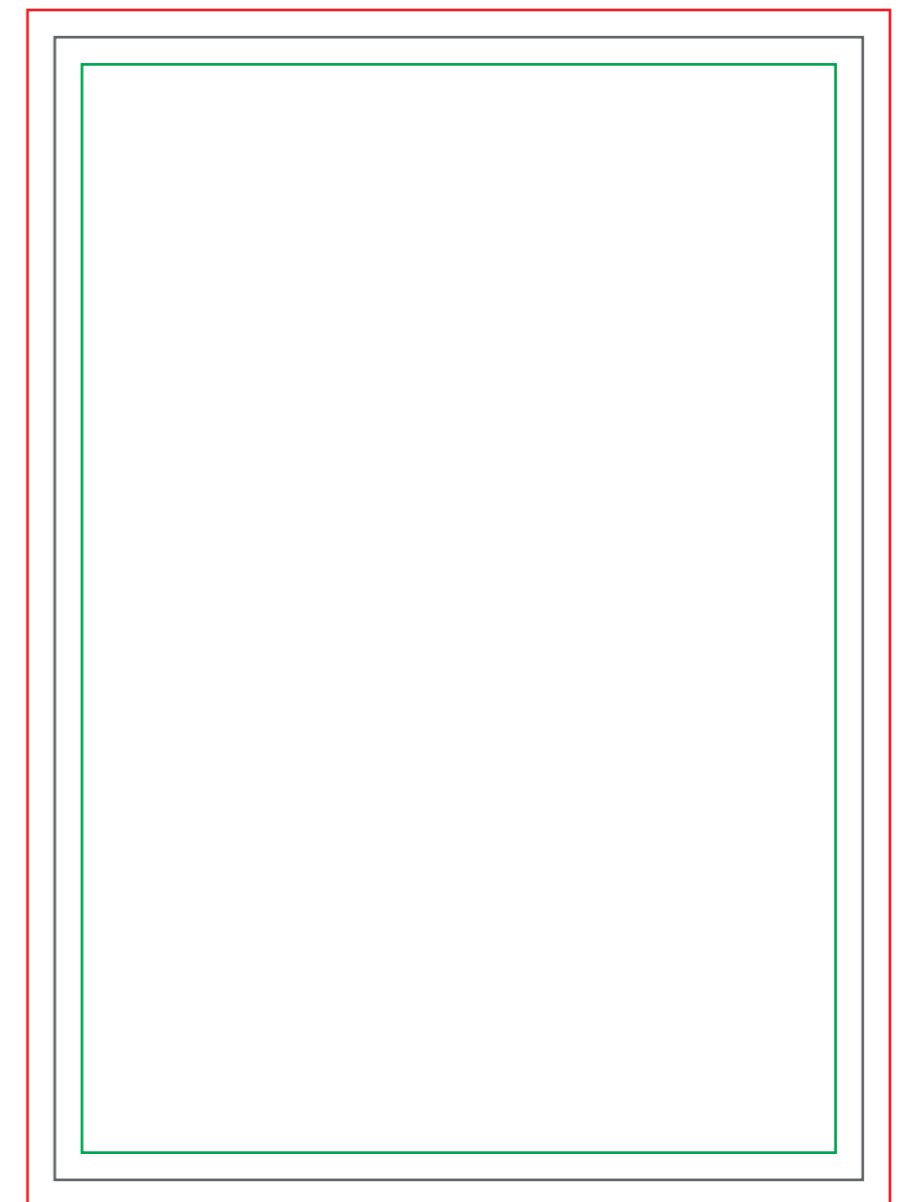
- \* Email to [artwork@acesign.com.au](mailto:artwork@acesign.com.au) for size less than 20MB
- \* Please using (Wetransfer, Google Drive or other free services) to upload your files for larger sizes and sent us the download link.
- \* **Please specify your invoice number when sending your files**



 Trim size	148.5mm W x 210mm H
 Bleed	158.5mm W x 220mm H
 Safe Print Area	138.5mm W x 200mm H

# A4 Hard Cover Booklet

## A4 Hard Cover Booklet (210x297mm)

### Artwork Specifications

- \* All files to be supplied as PDF file
- \* All files to be set up as four-colour CMYK not RGB colour mode
- \* All fonts must be outlined/converted to paths
- \* All images and elements to be embed without trim, crop and registration marks
- \* All images within the files must be at least 150dpi or better print resolution
- \* Please specify correct proportions if artwork size is not a 100% full size
- \* All bleeding requirements according to templates

### Sending Your Artwork

- \* Email to [artwork@acesign.com.au](mailto:artwork@acesign.com.au) for size less than **20MB**
- \* Please using (Wetransfer, Google Drive or other free services) to upload your files for larger sizes and sent us the download link.
- \* **Please specify your invoice number when sending your files**

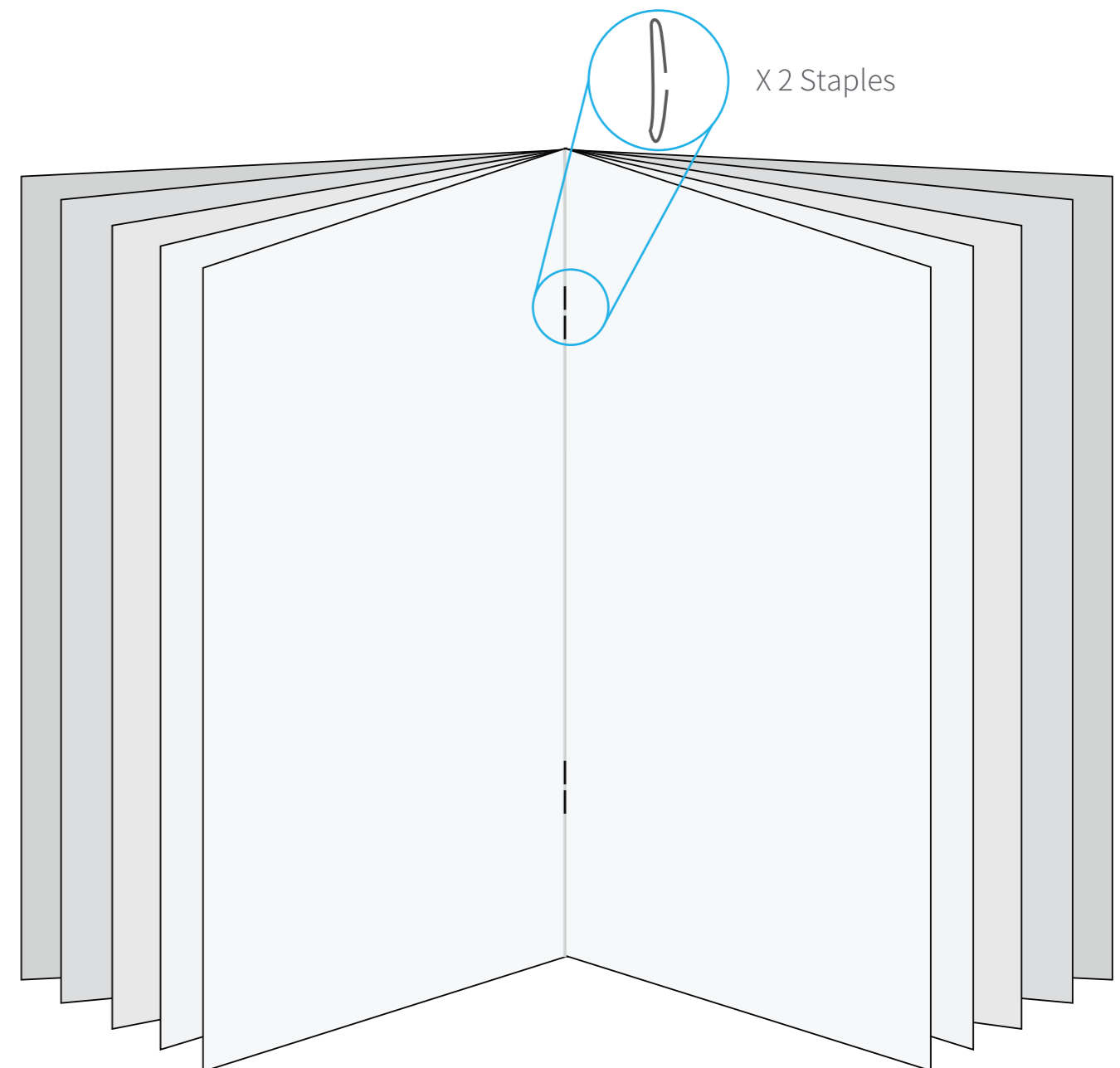

# A4 Hard Cover Booklet

## A4 Hard Cover Booklet (210x297mm)

### Artwork Specifications

- \* All files to be supplied as PDF file
- \* All files to be set up as four-colour CMYK not RGB colour mode
- \* All fonts must be outlined/converted to paths
- \* All images and elements to be embed without trim, crop and registration marks
- \* All images within the files must be at least 150dpi or better print resolution
- \* Please specify correct proportions if artwork size is not a 100% full size
- \* All bleeding requirements according to templates

### Sending Your Artwork

- \* Email to [artwork@acesign.com.au](mailto:artwork@acesign.com.au) for size less than **20MB**
- \* Please using (Wetransfer, Google Drive or other free services) to upload your files for larger sizes and sent us the download link.
- \* **Please specify your invoice number when sending your files**

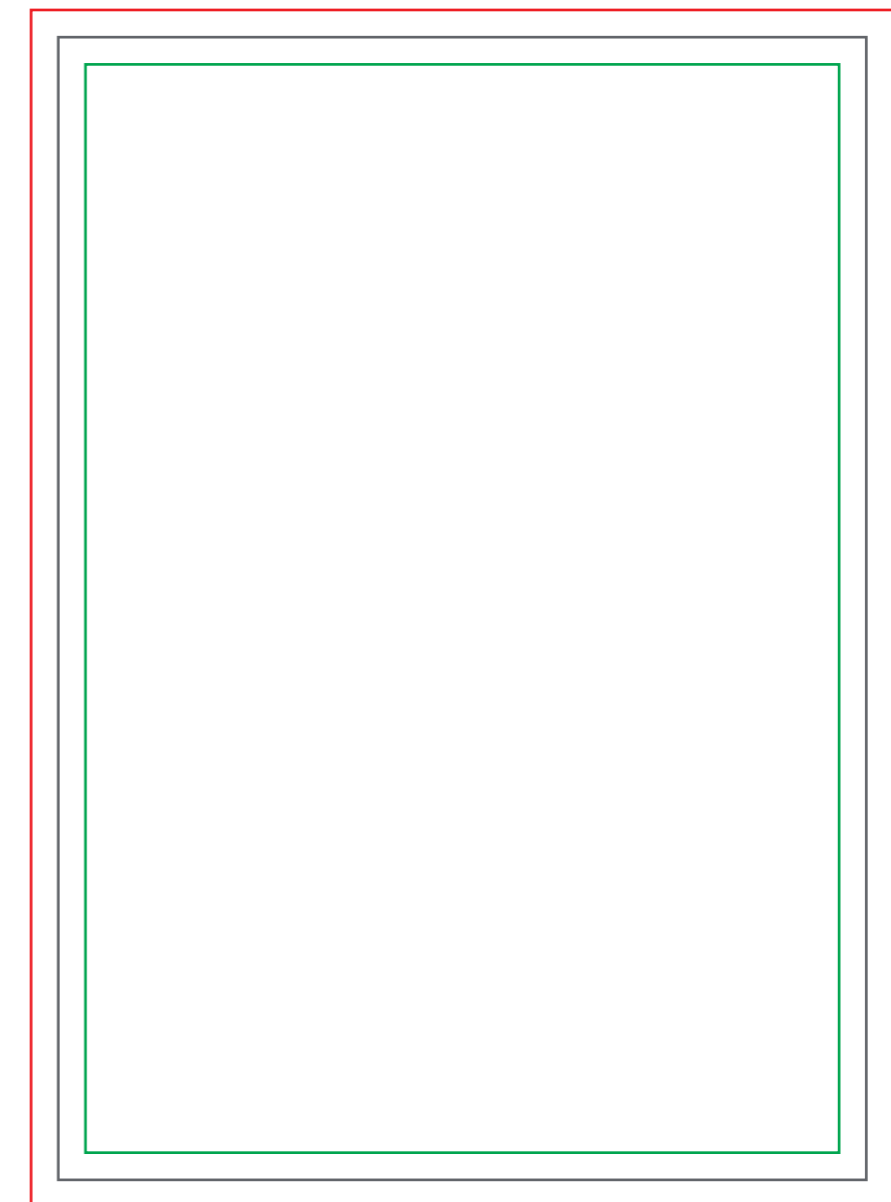

 Trim size	210mm W x 297mm H
 Bleed	220mm W x 307mm H
 Safe Print Area	200mm W x 287mm H

# DL Self Cover Booklet

## DL Self Cover Booklet (99x210mm)

### Artwork Specifications

- \* All files to be supplied as PDF file
- \* All files to be set up as four-colour CMYK not RGB colour mode
- \* All fonts must be outlined/converted to paths
- \* All images and elements to be embed without trim, crop and registration marks
- \* All images within the files must be at least 150dpi or better print resolution
- \* Please specify correct proportions if artwork size is not a 100% full size
- \* All bleeding requirements according to templates

### Sending Your Artwork

- \* Email to [artwork@acesign.com.au](mailto:artwork@acesign.com.au) for size less than **20MB**
- \* Please using (Wetransfer, Google Drive or other free services) to upload your files for larger sizes and sent us the download link.
- \* **Please specify your invoice number when sending your files**

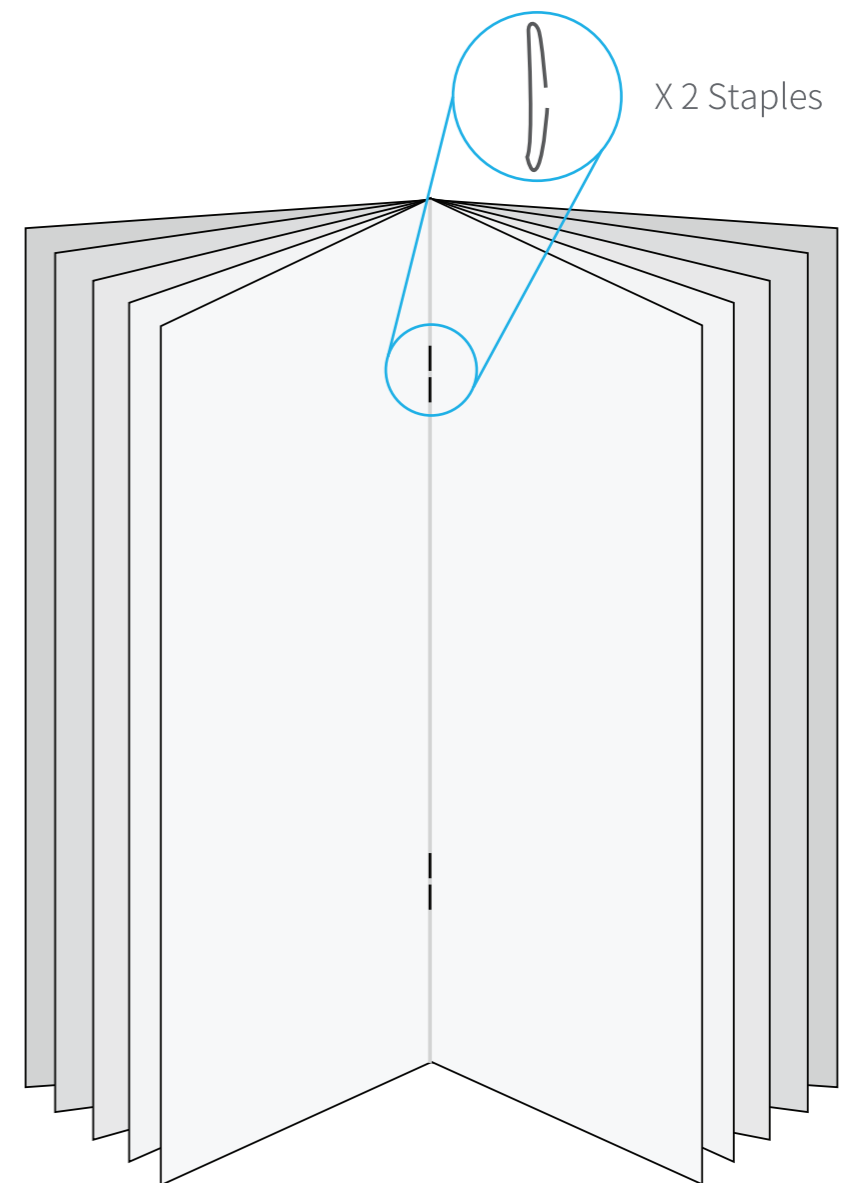

# DL Self Cover Booklet

## DL Self Cover Booklet (99x210mm)



### Artwork Specifications

- \* All files to be supplied as PDF file
- \* All files to be set up as four-colour CMYK not RGB colour mode
- \* All fonts must be outlined/converted to paths
- \* All images and elements to be embed without trim, crop and registration marks
- \* All images within the files must be at least 150dpi or better print resolution
- \* Please specify correct proportions if artwork size is not a 100% full size
- \* All bleeding requirements according to templates

### Sending Your Artwork

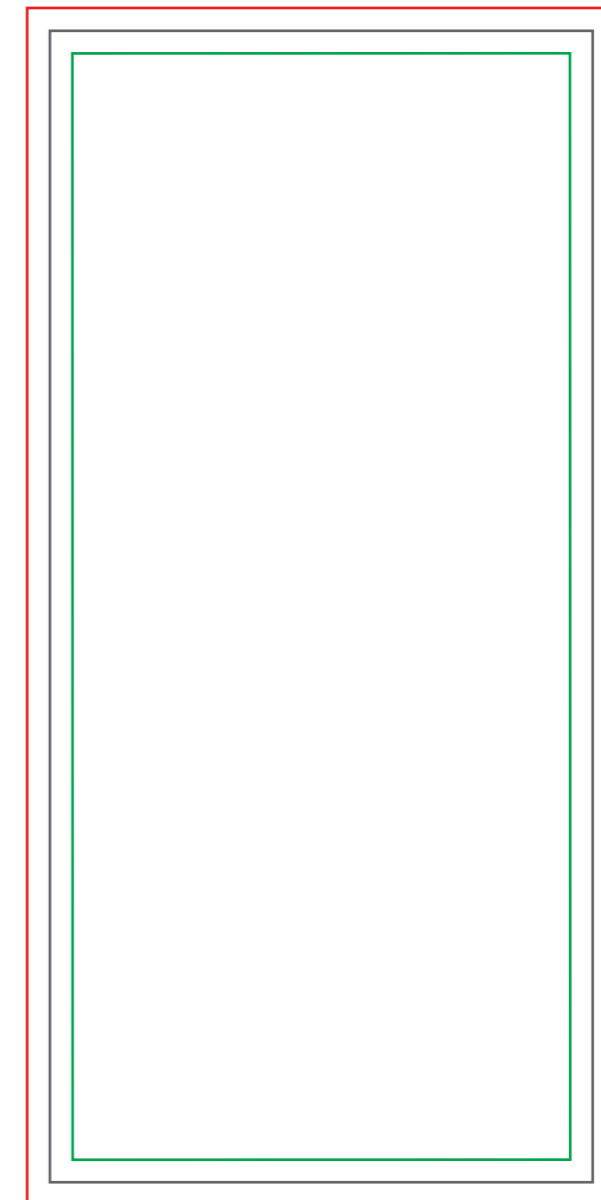
- \* Email to [artwork@acesign.com.au](mailto:artwork@acesign.com.au) for size less than **20MB**
- \* Please using (Wetransfer, Google Drive or other free services) to upload your files for larger sizes and sent us the download link.
- \* **Please specify your invoice number when sending your files**



 Trim size	99mm W x 210mm H
 Bleed	109mm W x 220mm H
 Safe Print Area	89mm W x 200mm H



# A5 Self Cover Booklet

## A5 Self Cover Booklet (148.5x210mm)

### Artwork Specifications

- \* All files to be supplied as PDF file
- \* All files to be set up as four-colour CMYK not RGB colour mode
- \* All fonts must be outlined/converted to paths
- \* All images and elements to be embed without trim, crop and registration marks
- \* All images within the files must be at least 150dpi or better print resolution
- \* Please specify correct proportions if artwork size is not a 100% full size
- \* All bleeding requirements according to templates

### Sending Your Artwork

- \* Email to [artwork@acesign.com.au](mailto:artwork@acesign.com.au) for size less than **20MB**
- \* Please using (Wetransfer, Google Drive or other free services) to upload your files for larger sizes and sent us the download link.
- \* **Please specify your invoice number when sending your files**

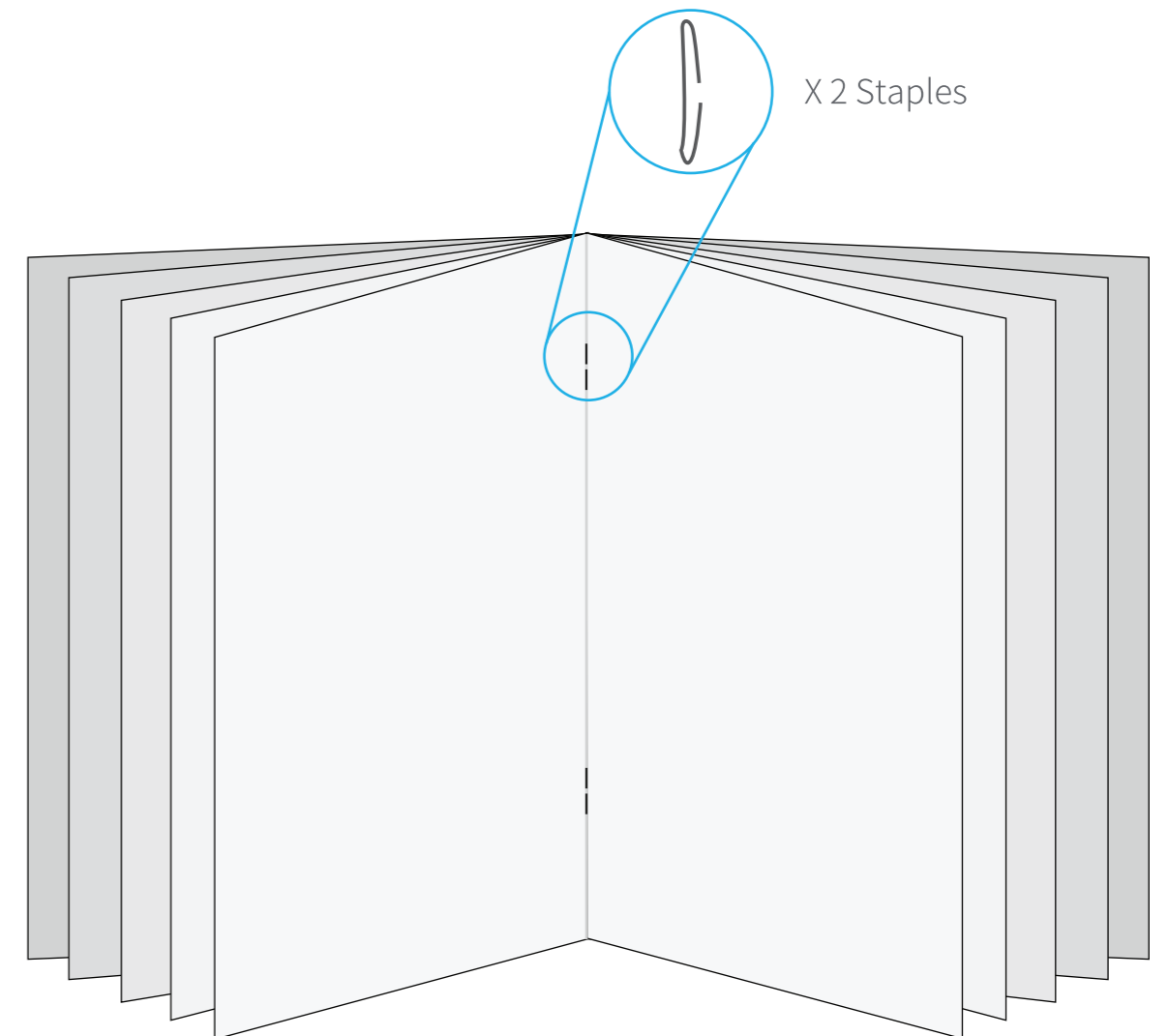

# A5 Self Cover Booklet

## A5 Self Cover Booklet (148.5x210mm)



### Artwork Specifications

- \* All files to be supplied as PDF file
- \* All files to be set up as four-colour CMYK not RGB colour mode
- \* All fonts must be outlined/converted to paths
- \* All images and elements to be embed without trim, crop and registration marks
- \* All images within the files must be at least 150dpi or better print resolution
- \* Please specify correct proportions if artwork size is not a 100% full size
- \* All bleeding requirements according to templates

### Sending Your Artwork

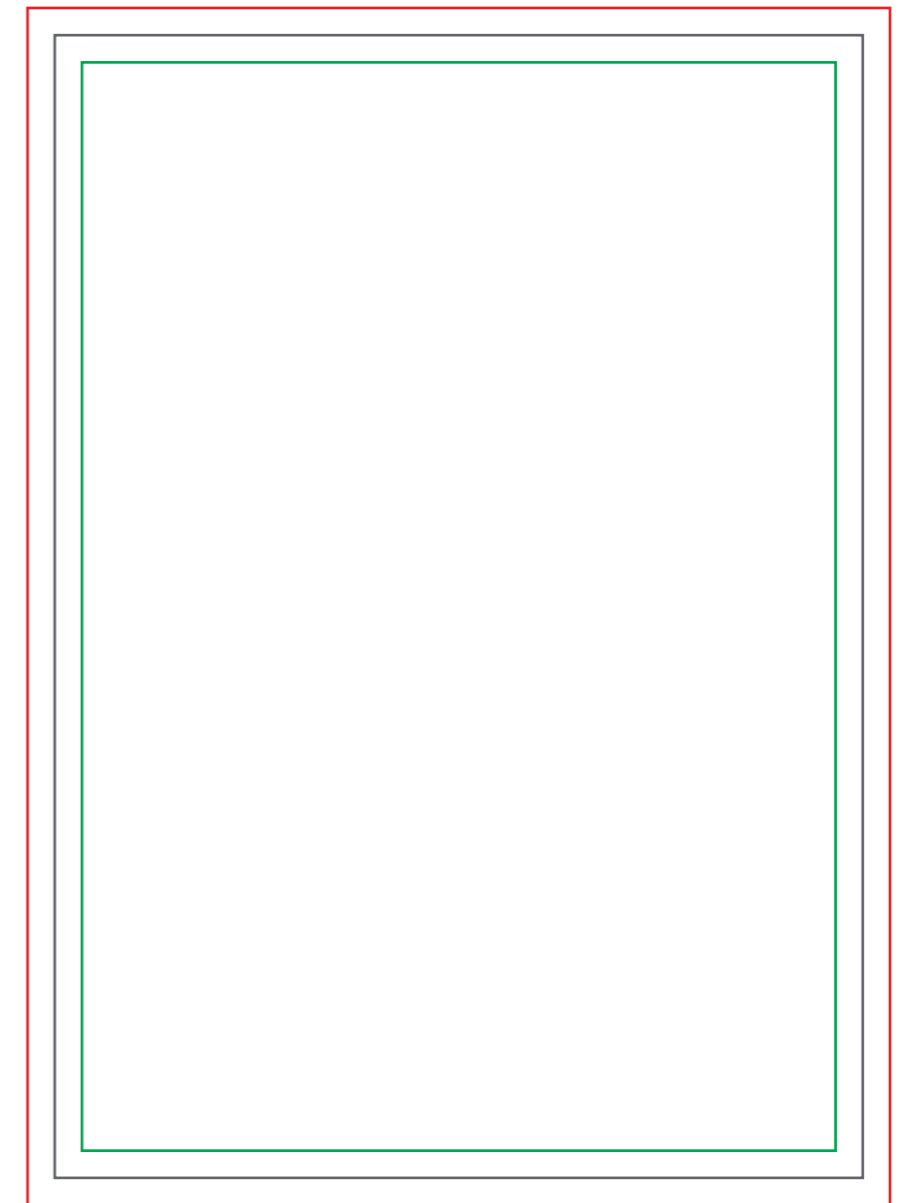
- \* Email to [artwork@acesign.com.au](mailto:artwork@acesign.com.au) for size less than 20MB
- \* Please using (Wetransfer, Google Drive or other free services) to upload your files for larger sizes and sent us the download link.
- \* **Please specify your invoice number when sending your files**



 Trim size	148.5mm W x 210mm H
 Bleed	158.5mm W x 220mm H
 Safe Print Area	138.5mm W x 200mm H

# A4 Self Cover Booklet

## A4 Self Cover Booklet (210x297mm)

### Artwork Specifications

- \* All files to be supplied as PDF file
- \* All files to be set up as four-colour CMYK not RGB colour mode
- \* All fonts must be outlined/converted to paths
- \* All images and elements to be embed without trim, crop and registration marks
- \* All images within the files must be at least 150dpi or better print resolution
- \* Please specify correct proportions if artwork size is not a 100% full size
- \* All bleeding requirements according to templates

### Sending Your Artwork

- \* Email to [artwork@acesign.com.au](mailto:artwork@acesign.com.au) for size less than 20MB
- \* Please using (Wetransfer, Google Drive or other free services) to upload your files for larger sizes and sent us the download link.
- \* **Please specify your invoice number when sending your files**

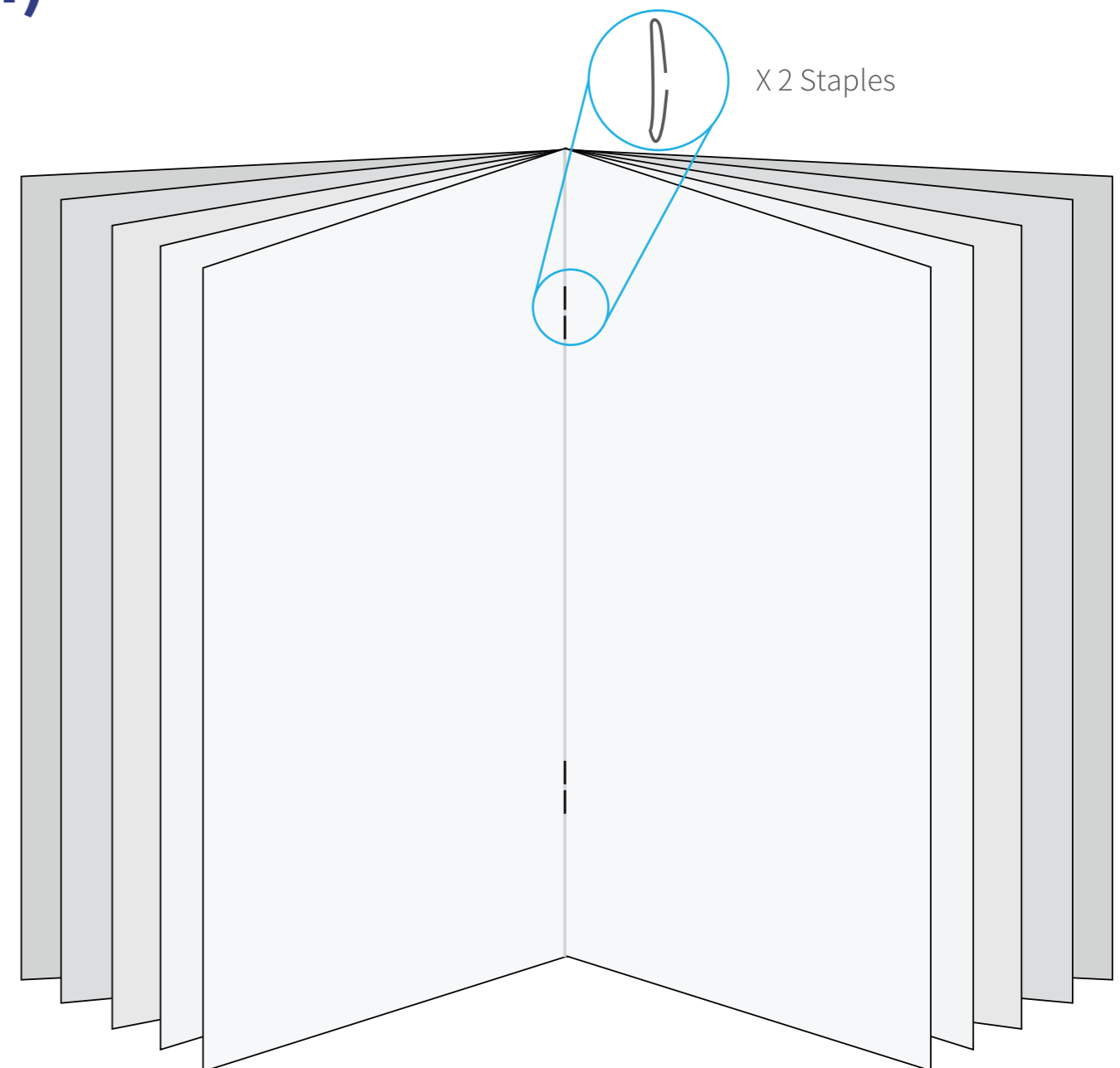

# A4 Self Cover Booklet

## A4 Self Cover Booklet (210x297mm)

### Artwork Specifications

- \* All files to be supplied as PDF file
- \* All files to be set up as four-colour CMYK not RGB colour mode
- \* All fonts must be outlined/converted to paths
- \* All images and elements to be embed without trim, crop and registration marks
- \* All images within the files must be at least 150dpi or better print resolution
- \* Please specify correct proportions if artwork size is not a 100% full size
- \* All bleeding requirements according to templates

### Sending Your Artwork

- \* Email to [artwork@acesign.com.au](mailto:artwork@acesign.com.au) for size less than 20MB
- \* Please using (Wetransfer, Google Drive or other free services) to upload your files for larger sizes and sent us the download link.
- \* **Please specify your invoice number when sending your files**

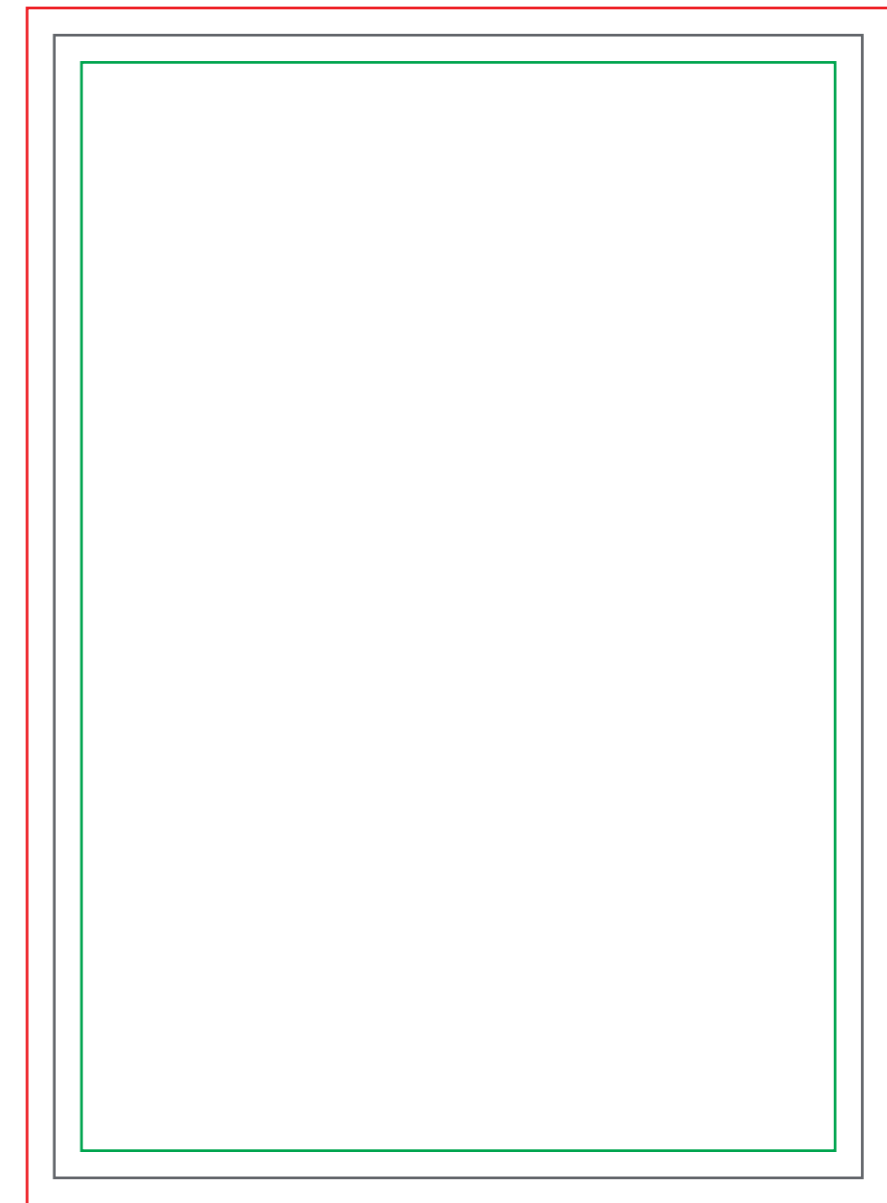

 Trim size	210mm W x 297mm H
 Bleed	220mm W x 307mm H
 Safe Print Area	200mm W x 287mm H